

Agilent 8566B Spectrum Analyzer **100 Hz to 22 GHz**

Technical Overview



Outstanding Precision and Capability



Agilent Technologies

The Agilent 8566B Spectrum Analyzer...

Designed for bench and system use, the 8566B offers superior measurement speed, microwave frequency accuracy, and sensitivity. Measure low-level signals up to 22 GHz with narrow resolution bandwidths. Synthesizer stability virtually eliminates long-term drift and residual FM.

Frequency range is 100 Hz to 22 GHz with a dc-coupled input. Preselected external mixers extend this coverage from 26.5 to 75 GHz. Other external mixers allow measurement to 325 GHz.

An internal bus and microcomputer control make possible many powerful operating and data processing features, as well as flexibility under computer control. Sixteen Kbytes of user RAM are available for storing trace data, instrument states, and custom downloadable programs (DLPs). All displayed information can be sent directly to a plotter when sweep time is greater than or equal to 20 ms.

Accurate measurements

Amplitude measurement range extends from +30 to -135 dBm with a 90 dB calibrated display.

Less than 1×10^{-9} /day frequency reference error and the spectrum analyzer selectivity allow high frequency accuracy even when you are measuring small signals in the presence of large ones.

...the Spectrum Analyzer that keeps getting better

Turbo speed option

Already a world leader in measurement speed, the 8566B can be made even faster with Option 002, which nearly doubles the internal processing speed of the analyzer. Some measurements can be made up to 50% faster, and overall throughput is typically improved by 5 to 25%. (Sweep speed is not affected by Option 002.)

The turbo option is compatible with all 8566B accessories, and it can be added to any 8566B without affecting specifications. (An 8566A must first be upgraded to a 8566B.)

Accessories and options

By adding measurement accessories and options, the 8566B spectrum analyzer fits into many applications, including electromagnetic compatibility (EMC) testing, broadband signal surveillance, and component stimulus response testing.

- EMI measurement accessories and software create systems for testing to commercial and military standards.
- Microwave tracking sources add scalar measurement capability.
- Preselected external mixers simplify millimeter-wave measurements from 26.5 to 75 GHz.
- Interactive test generator (ITG) soft-front-panel-based drivers speed software development.
- MIL-STD 45662A calibrations are available.

Custom Soft key programming

You can create complex measurement routines on an external controller, store the programs in user RAM, and execute them using a single custom soft key.

Simple measurement routines can be entered from the instrument front panel, stored in user RAM, and executed using a single custom soft key.

Turbo speed improvements

Operation	Standard 8566B	Turbo 8566B	Speed improvement
Trace dump	1083 ms	532 ms	51%
MKR AMPL	8.4 ms	3.7 ms	56%
Harmonics test	1007 ms	782 ms	22%
FFT	473 ms	243 ms	49%

EMC Measurement Solutions

Test systems tailored to your needs

For EMI troubleshooting and pre-qualification testing, use your 8566B spectrum analyzer with components and accessories from Agilent Technology's complete line of EMI products. The many offerings include current probes, line impedance stabilization networks (LISNs), antennas, positioning equipment, EMI measurement software, an RF preselector, and a quasi-peak adapter.

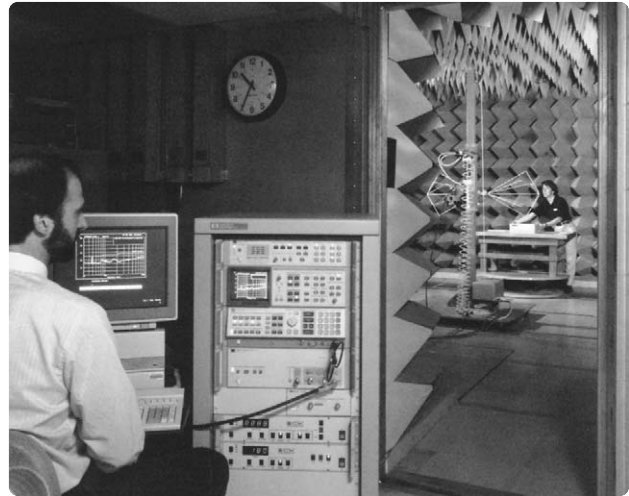
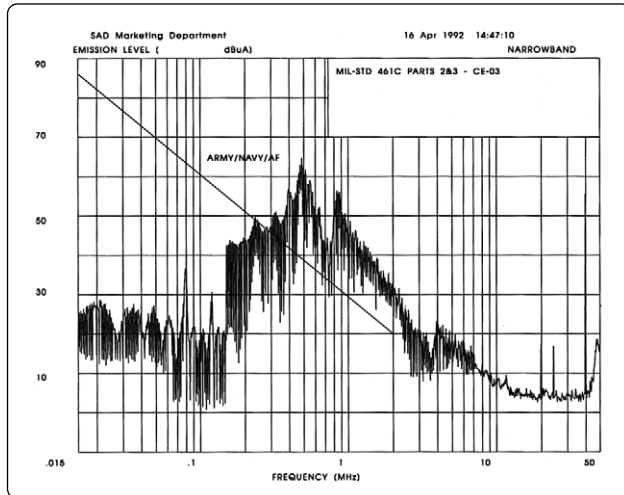

Commercial and MIL EMI receivers

The 8566B spectrum analyzer forms the heart of two powerful and flexible EMI receivers. These receivers are ideal for commercial and military EMI compliance testing from 20 Hz to 40 GHz.

The 8571A receiver is optimized for military EMI testing, making both peak and average detection measurements using impulse bandwidths. The 8572A includes all the features and capabilities of the 8571A, but adds quasi-peak detection and specialized IF bandwidths for commercial compliance measurements.

Both receivers offer ± 2 dB absolute amplitude accuracy over their full 20 Hz to 22 GHz frequency range, as required by MIL-STD 461 and CISPR Publication 16. For higher frequency measurements, a 22 to 40 GHz block downconverter can be added. The receivers include a built-in, 1 to 26.5 GHz amplifier and a 20 Hz to 50 MHz input port with a built-in limiter and rugged attenuator. They are also compatible with EMI measurement software and complete line of test accessories.

Smart enough to make its own decisions...

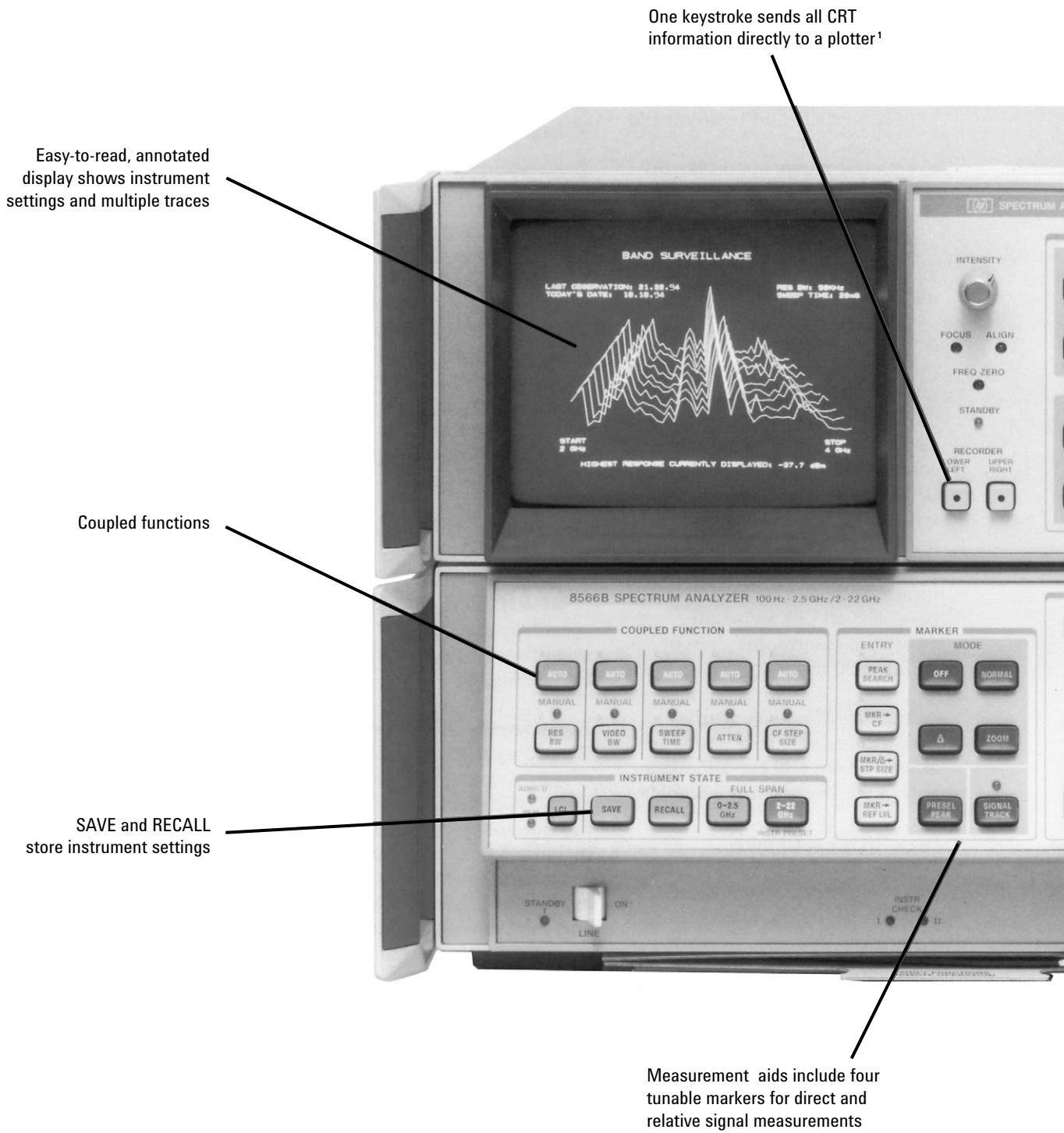

1. Instrument sweeptimes greater than or equal to 20 ms.

...with precision and speed

Powerful signal and trace-processing functions perform complex data analysis

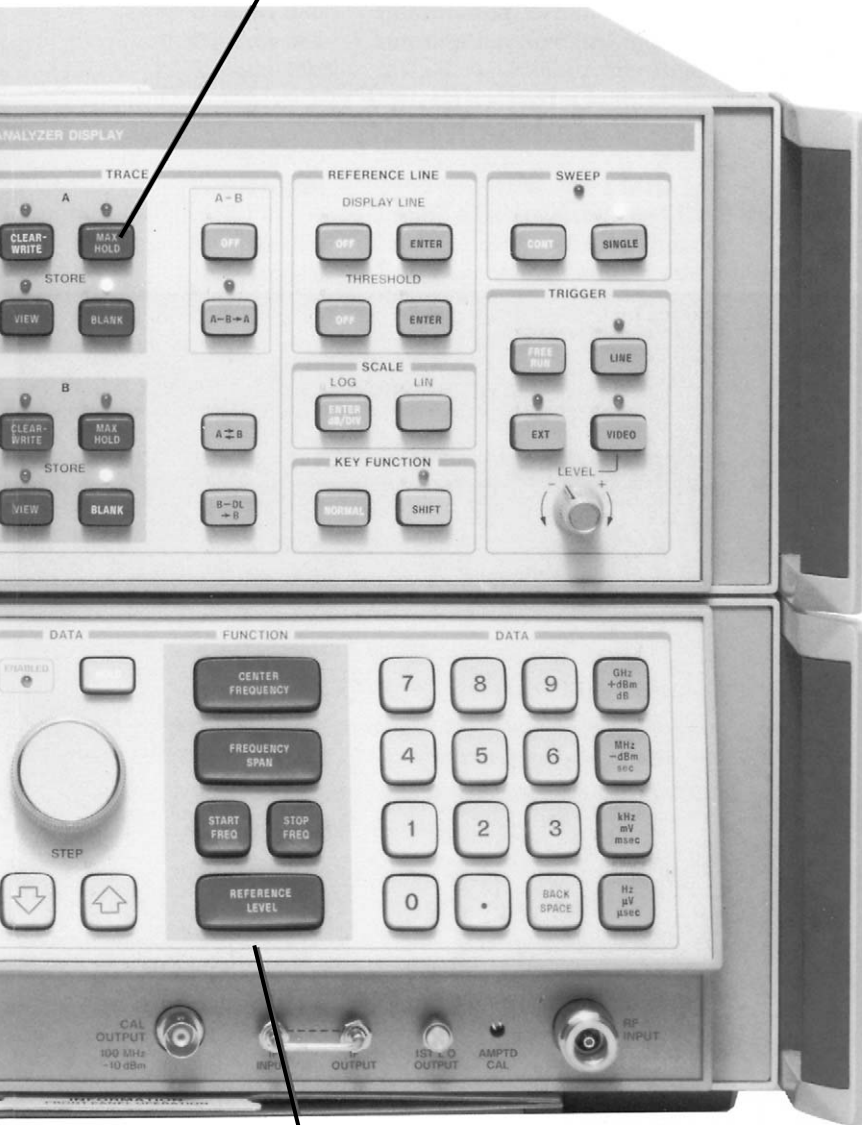

Dedicated keys make basic operations easy

The 8566B offers

- Exceptional microwave performance
- Decision-making capability
- Enhanced processing speed
- Preselected millimeter coverage
- Advanced functions
- Downloadable programming capability
- Distributed processing with a computer
- Proven reliability, performance, and support

Interactive function and data controls simplify operation

Accessories That Enhance Performance

Millimeter mixers

Preselected mixers

The 11974 Series preselected mixers eliminate the need for time-consuming signal identification routines at millimeter frequencies. With preselection, no images or multiples are generated to confuse measurements. These external mixers allow you to quickly locate true signals, and they simplify software development for automated measurements. The 11974 Series mixers are available in four bands covering 26.5 to 75 GHz.

Harmonic mixers

The 11970 Series waveguide mixers are general-purpose external harmonic mixers. They offer flat frequency response and low conversion loss without requiring external dc bias or tuning adjustment. The 11970 Series mixers are offered in six bands covering 18 to 110 GHz.

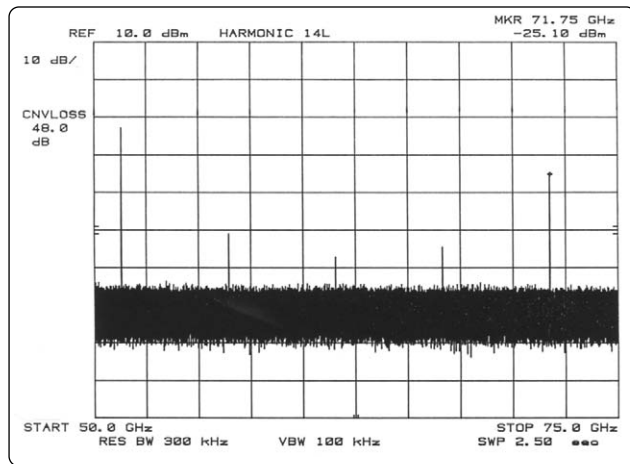
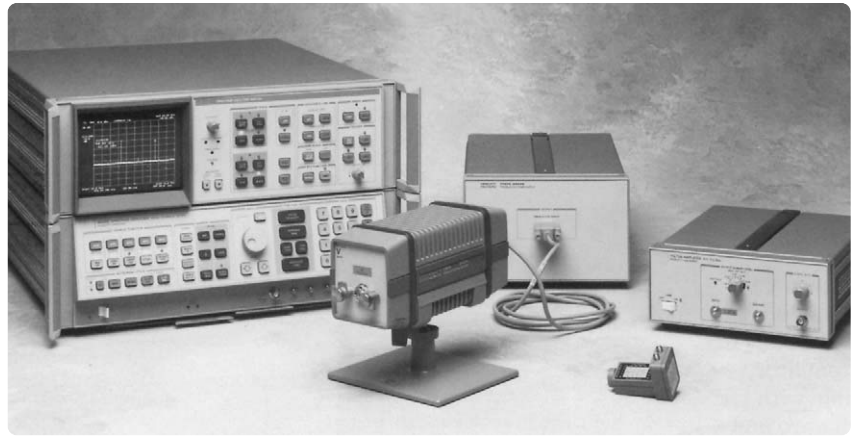

Preselected mixers eliminate images and multiples.

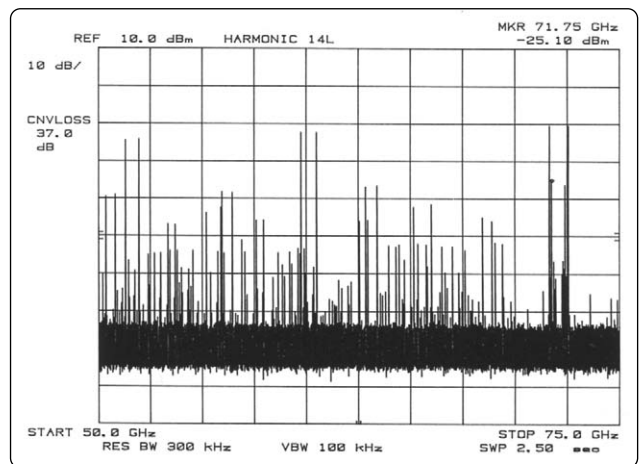

Harmonic mixing extends frequency range.

Tracking Sources

Add high dynamic range scalar measurement capability to the 8566B. The 85644A and 85645A portable tracking sources allow you to use your spectrum analyzer for measuring transmission and reflection characteristics of devices. You can also characterize harmonic distortion, intermodulation distortion, spurious products, and more.

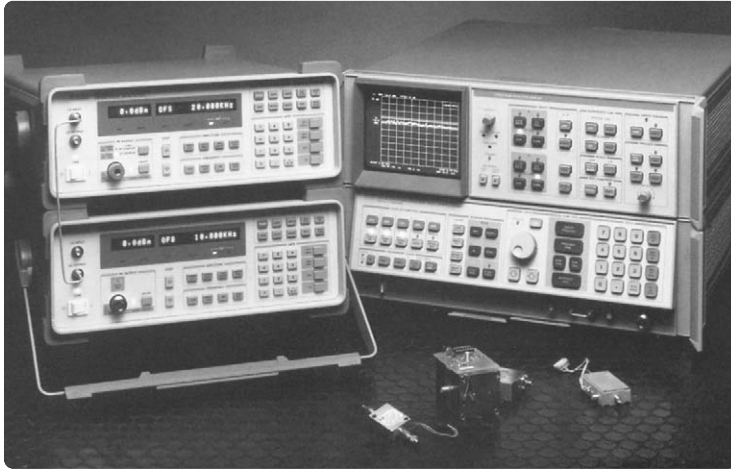

The tracking sources give the 8566B dynamic range greater than 125 dB up to 12.5 GHz and greater than 105 dB through 22 GHz.

Other features include:

- Swept offset tracking for mixer testing and swept TOI measurements
- Up to +10 dBm leveled output power
- Standalone CW source capability

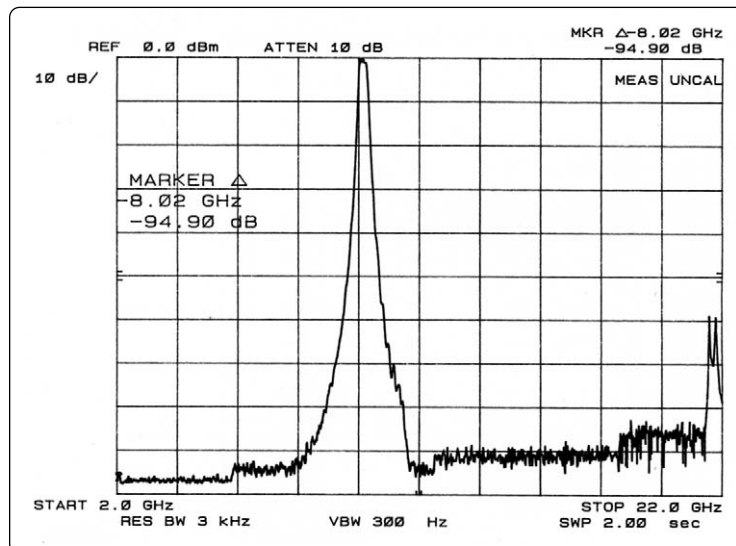

High dynamic range scalar measurement

Microwave preamplifier

Boost the sensitivity of the 8566B spectrum analyzer with the 8449B microwave preamplifier. This low noise, high gain preamplifier has a frequency range of 1 to 26.5 GHz. Sensitivity improvements of up to 25 dB allow you to detect and analyze very low level signals in dramatically reduced time, using wider bandwidths. Low return loss on the input and output ports of the preamplifier minimizes mismatch uncertainty.

Displayed average noise level

0 dB attenuation, 10 Hz RBW (characteristic)

1.0 to 2.5 GHz	-155 dBm
2.0 to 5.8 GHz	-154 dBm
5.8 to 12.5 GHz	-150 dBm
12.5 to 18.6 GHz	-144 dBm
18.6 to 22 GHz	-140 dBm



Computers and plotters

The 8566B spectrum analyzer works with computers that support BASIC.

Specifications

Specifications describe the instrument's warranted performance over the 0 ° to 55 °C temperature range (unless otherwise noted), with autocoupled function operation and preselector tracking optimized.

Characteristics provide information about non-warranted instrument performance.

Frequency

Measurement range 100 Hz to 22 GHz, dc-coupled input; up to 325 GHz with external mixers

Frequency reference error

Aging rate < 1 x 10⁻⁹/day and < 2.5 x 10⁻⁷/year

Temperature stability < 7 x 10⁹ over 0 ° to 55 °C range

Center frequency 0 Hz to 22 GHz

Center frequency readout accuracy

Spans ≤ n x 5 MHz ± (2% of frequency span + frequency reference error x center frequency +10 Hz)

Spans > n x 5 MHz ± (2% of frequency span + n x 100 kHz + frequency reference error x center frequency) where n is the harmonic mixing number, depending on center frequency:

n center frequency

1 100 Hz to 5.8 GHz

2 5.8 to 12.5 GHz

3 12.5 to 18.6 GHz

4 > 18.6 GHz

(After adjusting freq zero, add 30% of RES BW setting if error correction is not used.)

Zero span ± (frequency reference error x center frequency)

Specifications (continued)

Frequency span

0 Hz, 100 Hz to 22 GHz over 10 division CRT horizontal axis; variable in approximately 1% increments. Two FULL SPAN keys select spans from 0 to 2.5 GHz and from 2 to 22 GHz.

Frequency span readout accuracy

Spans $\leq n \times 5$ MHz	$\pm 1\%$ of indicated frequency separation
Spans $> n \times 5$ MHz	$\pm 3\%$ of indicated frequency separation
Start or Stop Frequency	Same as center frequency

Resolution

Resolution bandwidth 3 dB bandwidths of 10 Hz to 3 MHz in a 1, 3, 10 sequence. Bandwidth may be selected manually or coupled to frequency span (AUTO mode).

3 dB bandwidth accuracy

3 MHz	$\pm 20\%$
3 kHz to 1 MHz	$\pm 10\%$
10 Hz to 1 kHz	$\pm 20\%$

(30 kHz and 100 kHz bandwidth accuracy figures apply only with $\leq 90\%$ relative humidity, 40 °C.)

60 dB/3 dB bandwidth selectivity ratio

100 kHz to 3 MHz	$< 15:1$
3 kHz to 30 kHz	$< 13:1$
30 Hz to 1 kHz	$< 12:1$

(60 dB points on 10 Hz bandwidth are separated by < 100 Hz.)

Bandwidth shape

Synchronously tuned, approximately Gaussian

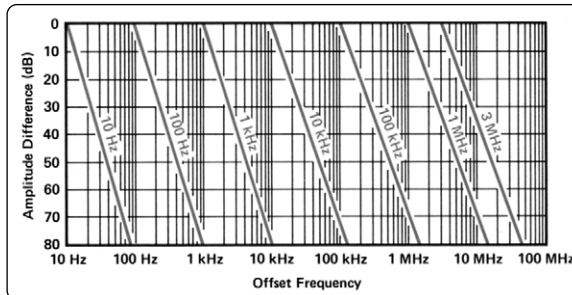

Figure 1. Typical spectrum analyzer resolution

Stability

Residual FM (typical) For fundamental mixing ($n = 1$) < 50 kHz peak-to-peak, freq. span > 5 MHz.

Drift Because analyzer is phase-locked at beginning of each sweep, drift occurs only during time of one sweep.

Frequency span	Center frequency drift ¹
< 100 kHz	< 10 Hz/min of sweep time
100 kHz to 5 MHz	< 500 Hz/min of sweep time
≥ 5 MHz	< 5 KHz/min of sweep time

Spectral purity

Noise sidebands (for frequency span < 25 kHz – except 100 kHz offset – and center frequency from 100 Hz to 5.8 GHz)

Offset from carrier sideband level

320 Hz	-80 dBc/Hz
1 kHz	-85 dBc/Hz
10 kHz	-90 dBc/Hz
100 kHz	-105 dBc/Hz

1. Typical, after 1 hr warmup at stabilized temp COUPLED FUNCTION not required.

Specifications (continued)

Typical noise sideband performance

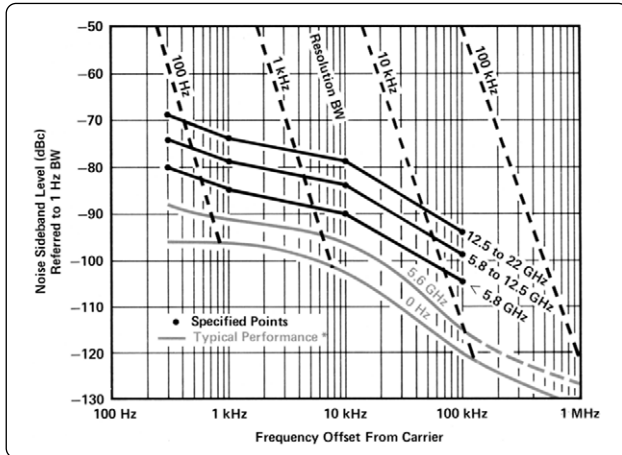

Figure 2. Single sideband noise normalized to 1 Hz BW vs offset from carrier

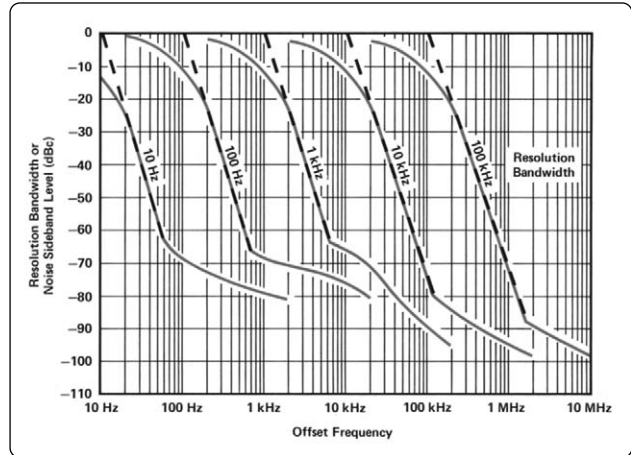

Figure 3. Typical analyzer and SSB noise at 5.0 GHz center frequency. May be limited by average noise level.

Power-line-related sidebands

(for line conditions specified in Power Requirements section)

SIDEBANDS

Offset from carrier	Center frequency				
	≤ 100 MHz	> 100 MHz to 5.8 GHz	6.8 to 12.6 GHz	12.6 to 18.6 GHz	18.6 to 22 GHz
< 360 Hz	-70 dBc	-60 dBc	-64 dBc	-60 dBc ¹	-58 dBc ¹
360 kHz to 2 kHz	-75 dBc	-75 dBc ¹	-69 dBc	-65 dBc ¹	-63 dBc ¹
> 2 kHz	-80 dBc	-80 dBc ¹	-74 dBc ¹	-70 dBc ¹	-63 dBc ¹

Amplitude

Measurement range

Measurement range is the total amplitude range over which the analyzer can measure signal responses. The low value is determined by sensitivity (10 Hz RBW and 0 dB RF input attenuation) and the high value by damage level.

Tuned frequency

Non-preselected
 100 Hz to 50 kHz
 50 kHz to 1 MHz
 1 MHz to 2.5 GHz

Range

-95 to +30 dBm
 -112 to +30 dBm
 -134 to +30 dBm

Preselected

2.0 to 5.8 GHz
 5.8 to 12.5 GHz
 12.5 to 18.6 GHz
 18.6 to 22 GHz

-132 to +30 dBm
 -125 to +30 dBm
 -119 to +30 dBm
 -114 to +30 dBm

Displayed values

Scale (over a 10 division CRT vertical axis with 0 dB reference level at top graticule line)

Calibration

Log 10 dB/div for 90 dB display from reference level.

Expanded from reference level:

5 dB/div for 50 dB display

2 dB/div for 20 dB display

1 dB/div for 10 dB display

Linear 10% of ref level/div when calibrated voltage

1. Typical

Specifications (continued)

Reference level

Range

Log	+30.0 to -99.9 dBm or equivalent in dBmV, dBμV, volts. Readout expandable to +60.0 dBm to -119.9 dBm (-139.9 dBm for < 1 kHz RBW) ¹
Linear	7.07 V to 2.2 μV full scale. Readout expandable to 223.6 V to 2.2 μV (0.22 μV for < 1 kHz RBW) ¹

Accuracy

The sum of the following factors determines the accuracy of the reference level readout. Measurement technique used after calibration with CAL signal determines applicability of uncertainty sources. Specifications given with preselector tracking optimized using MARKER PRESELECTOR PEAK.

With corrected readout (SHIFT W and SHIFT X executed just prior to measurement), 20 ° to 30 °C temperature range, and minimum one hour warmup time.

Calibrator uncertainty ±0.3 dB

Frequency response (flatness) uncertainty
(10 dB attenuation)

100 Hz to 2.5 GHz	±0.6 dB
2.0 to 12.5 GHz	±1.7 dB
12.5 to 20 GHz	±2.2 dB
20 to 22.0 GHz	±3.0 dB

Cumulative, 100 Hz to 20 GHz ±2.2 dB

Absolute amplitude calibration uncertainty

The uncertainty of setting the frequency response curve absolutely when using the internal CAL signal or other calibration signal in the 100 Hz to 2.5 GHz band (10 dB input attenuation).

±0.6 dB

Resolution bandwidth switching uncertainty

Referenced to 1 MHz RES BW

10 Hz	±1.1 dB
30 Hz	±0.4 dB
100 Hz to 1 MHz	±0.2 dB
3 MHz	±0.2 dB

Log scale switching uncertainty ±0.1 dB

Log fidelity

Incremental ±0.1 dB/dB over 0 to 80 dB display

Cumulative

10 Hz RBW ≤ ±2.1 dB over 0 to 90 dB

≥ 30 Hz RBW ≤ ±1.5 dB over 0 to 90 dB

≤ ±1.0 dB over 0 to 80 dB

Linear fidelity < ±3% of reference level over top 9-1/2 divisions of the display

IF gain uncertainty Reference to -10 dBm; reference level with 10 dB input attenuation.

Reference level

RBW ≥ 3 kHz	0 to -59.9 dBm ≤ ± 0.3 dB -60 to -100 dBm ≤ ±1.0 dB
RBW 100 Hz-1 kHz	0 to -79.9 dBm ≤ ± 0.3 dB -80 to -100 dBm ≤ ± 1.0 dB
RBW 30 Hz	0 to -79.9 dBm ≤ ± 0.3 dB -80 to -100 dBm ≤ ±2.0dB
RBW 10 Hz	0 to -79.9 dBm ≤ ±1.0 dB -80 to -100 dBm ≤ ±2.0dB

1. Maximum total input power not to exceed +30 dBm damage level

Specifications (continued)

Log digitization uncertainty

10 dB/div	±0.2dB
5 dB/div	±0.1 dB
2 dB/div	± 0.04 dB
1 dB/div	± 0.02 dB

Linear digitization uncertainty ± 0.2% of ref level

Error correction accuracy (applicable when SHIFT W and SHIFT X are executed)	± 0.4 dB
--	----------

Reference line accuracy Equals the sum of reference level accuracy plus the scale fidelity between the reference level and the reference line level.

Dynamic range

Spurious responses (signals generated by the analyzer due to input signals) for signals < -40 dBm at the input mixer, all harmonic and intermodulation distortion > 70 dB below input signal.

Second harmonic distortion (for mixer levels < -40 dBm)

100 Hz to 50 MHz	< -70 dBc
50 to 700 MHz	< -80 dBc
700 MHz to 2.5 GHz	< -70 dBc

For mixer levels ≤ -10 dBm

2 to 22 GHz	<-100 dBc
-------------	-----------

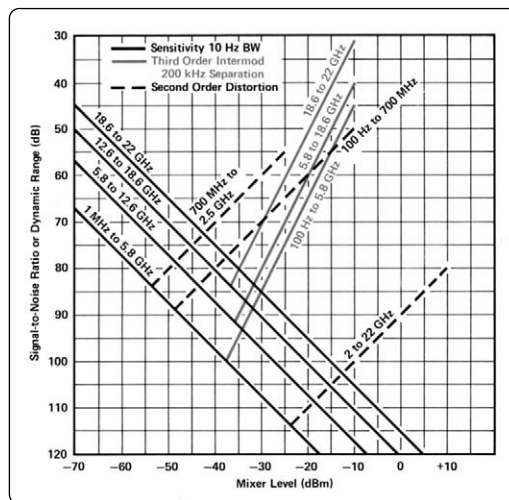

Figure 4. Typical optimum dynamic range

Third order intermodulation distortion

Third order intercept (TOI)

100 Hz to 5 MHz	> +5 dBm
5 MHz to 5.8 GHz	> +7 dBm
5.8 GHz to 18.6 GHz	> +5 dBm
18.6 to 22 GHz	> +5 dBm (typical)
2 to 22 GHz, for > 100 MHz	> +50 dBm (typical) signal separation

Image, multiple, and out-of-band responses

Image responses are due to input signals that are two times the IF frequency above or below the tuned frequency. Multiple responses are due to input signals mixing with more than one LO harmonic. Out-of-band responses are due to input signals outside of the selected frequency band.

Specifications (continued)

Applied frequency (GHz)	Tuned frequency				
0 to 2.5	0 to 2.5	2.0 to 5.8	5.8 to 12.5	12.5 to 18.6	18.6 to 22.0
0 to 2.5	NA	-60 dBc	60 dBc	-60 dBc	-60 dBc
2.0 to 5.8	-60 dBc	-70 dBc	-60 dBc	-60 dBc	-60 dBc
5.8 to 12.5	-50 dBc	-60 dBc	-70 dBc	-60 dBc	-60 dBc
12.5 to 18.6	-45 dBc	-60 dBc	-60 dBc	-70 dBc	-60 dBc
18.6 to 22.0	-40 dBc	-60 dBc	-60 dBc	-60 dBc	-70 dBc ¹

Residual responses (signals displayed by the analyzer independent of input signals), 0 dB input attenuation, no input signal.

100 Hz to 5.8 GHz	< -100 dBm ²
5.8 to 12.5 GHz	< -95 dBm
12.5 to 18.6 GHz	< -85 dBm
18.6 to 22 GHz	< -80 dBm

Gain compression < 1.0 dB, 100 Hz to 22 GHz. with < -5 dBm at input mixer

Displayed average noise level (sensitivity)

0 dB input attenuation, 10 Hz RBW

100 Hz to 50 kHz	< -95 dBm
50 kHz to 1.0 MHz	< -112 dBm
1.0 MHz to 2.5 GHz	< -134 dBm
2.0 to 5.8 GHz	< -132 dBm
5.8 to 12.5 GHz	< -125 dBm
12.5 to 18.6 GHz	< -119 dBm
18.6 to 22 GHz	< -114 dBm

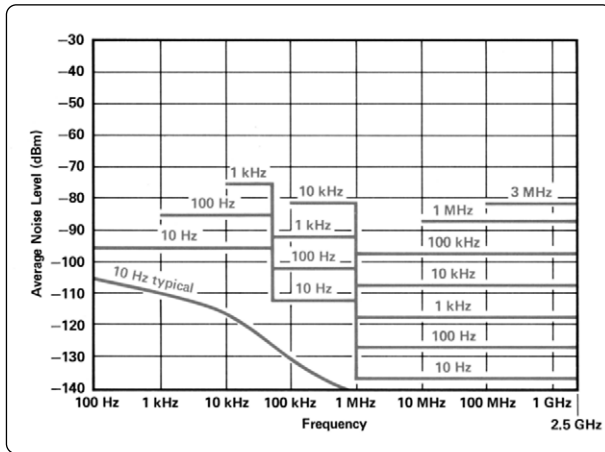

Figure 5. Specified average displayed noise level, 100 Hz to 2.5 GHz, non-preselected tuning range.

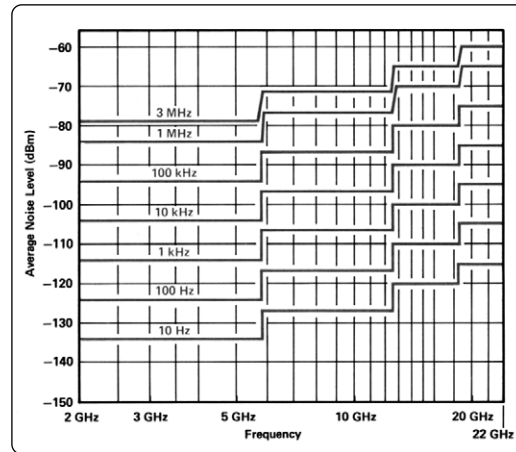

Figure 6. Specified average displayed noise level, 2.0 to 22 GHz, preselected tuning range.

Marker (frequency and amplitude are read out continuously)

Marker type **Frequency accuracy**

Normal Same as center frequency accuracy

Delta Same as frequency span accuracy

Amplitude accuracy

Normal Same as reference level accuracy + scale fidelity between the reference level and marker position

Delta Same as frequency response uncertainty and scale fidelity between two markers

Sweep time accuracy (1 μ s to 1500s full sweep)

< 200 second sweep time $\pm 10\%$

> 200 second sweep time $\pm 30\%$

1. Image responses: -60 dBc, 18.6 – 20.0 GHz; -50 dBc, 20.0 – 22 GHz
2. Limited by the appropriate DANL or -100 dBm, whichever is greater.

Specifications (continued)

Inputs

RF input 100 Hz to 22 GHz, precision type-N female connector, dc-coupled

Maximum input level

ac Continuous power: +30 dBm from 50 ohm source
Mixer protected by diode limiter, 100 Hz-2.5 GHz
Pulse power: ≤ 100 W, 10 μ s pulse width with ≥ 50 dB input attenuation
(≤ 0 dBm peak power to input mixer)
dc < 100 mA damage level

Input attenuator 0 to 70 dB in 10 dB steps

SWR (typical)	Tune frequency		
Input attenuation	100 Hz to 2.5 GHz	2.5 GHz to 5.8 GHz	5.8 GHz to 22 GHz
10 dB	1.2	1.5	1.9
0 dB ¹	2.3	3.0	3.0

Outputs

Calibrator (front panel)

100 MHz \pm (frequency reference error x 100 MHz)
-10 dBm \pm 0.3 dB; 50 ohm impedance, nominal

1st LO (front panel)

2.3 to 6.1 GHz; $> +5$ dBm;
50 ohm impedance, nominal

Sweep and tune output (rear panel)

-1 V/GHz of tuned frequency \pm (2% + 10 mV)
10 kohm impedance, nominal

Display outputs (typical parameters)

X, Y, and Z outputs for auxiliary CRT displays.
X, Y 1V for full deflection
Z 0 to 1 V intensity modulation, -1 V blank
BLANK TTL level > 2.4 V for blanking
Compatible with most oscilloscopes.

Recorder outputs (typical parameters)

Outputs to drive all current X-Y recorders using positive pen coils or TTL pen uplift.

Horizontal sweep output (X-axis)

A voltage proportional to the horizontal sweep of the frequency sweep generator. 0 V for left edge, +10 V for right edge; 1.7 kohm impedance, nominal.

Video output (Y-axis)

Detected video output (before A-D conversion) proportional to vertical deflection of the CRT trace 100 mV/div from 0 to 1 V; < 475 ohm impedance, nominal

Penlift output (Z-axis)

During sweep, pen down 0 V from 10 ohm source
During retrace, pen up +15 V from 10 kohm source

21.4 MHz output (rear panel, typical)

21.4 MHz; 50 ohm impedance, nominal: -20 dBm for a signal at reference level. In log scales, the IF output logarithmically related to RF input signal; in linear, the output is linearly related.

Frequency reference (rear panel, typical)

10.000 MHz, 0 dBm; 50 ohm output impedance

10 MHz output (rear panel, typical)

≥ 5 dBm to ohm output impedance

Video output 0 to 2 V, > 10 ohm output impedance

Display

Cathode ray tube Post deflection accelerator, aluminized P31 phosphor, electrostatic focus and deflection.

Viewing area Approximately 9.6 cm vertically by 11.9 cm horizontally (3.8 in x 4.7 in)

1. When tuned to within ± 3 MHz of signal

General Specifications

Environmental

Temperature

Operation 0 ° to 55 °C

Storage -40 ° to 75 °C

Increased internal temperatures may result if the rear panel air filters are not cleaned regularly.

Altitude

Operation ≤ 3 4,572 m (15,000 ft)

Storage ≥ 15,240 m (50,000 ft)

Power requirements 50 to 60 Hz; 100,200, 120,220, or 240 V (+5%, -10%); approximately 650 VA (40 VA in standby). 400 Hz operation with Option 400.

Humidity

Operation Type tested to 95% relative humidity, 25 ° to 40 °C, except as noted in electrical specifications.

Storage 5% to 90% relative humidity, 0 ° to 40 °C

EMI Conducted and radiated interference is within the requirements of MIL-STD-461C, Part 7 RE02 and CE03 (Air Force), and CISPR Publication 11; VDE 0871 and FTZ 526/527/79.

Warm-up time

Operation Requires 30 minute warm-up from cold start, 0 ° to 55 °C. Internal temperature equilibrium is reached after 2-hour warm-up at stable outside temperature.

Frequency reference (typical)

Frequency reference aging rate attained after 24 hour warm-up from cold start at 25 °C. Frequency is within 1×10^{-8} of final stabilized frequency within 30 minutes.

Weight

Total, net	50 kg (112 lb)
RF section, net	29 kg (65 lb)
IF display section, net	21 kg (47 lb)
RF section, shipping	35 kg (78 lb)
IF display section, shipping	27 kg (60 lb)

Dimensions

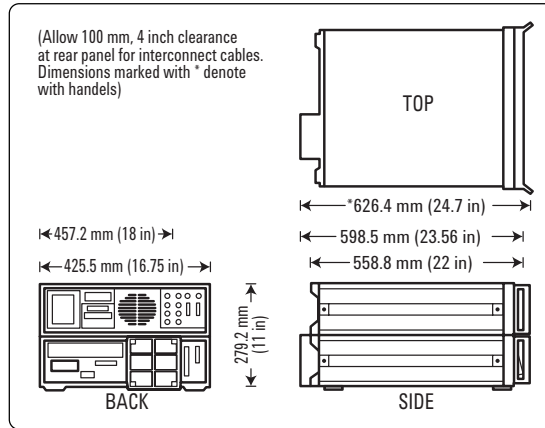
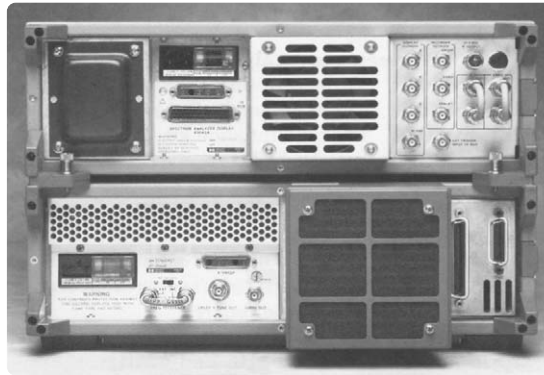

Figure 7. Instrument dimensions with and without handles



Remote operation

The standard 8566B operates on the interface bus (GP-IB). All analyzer control settings (with the exception of VIDEO TRIGGER LEVEL, FOCUS, ALIGN, INTENSITY, FREQ ZERO, AMPTD CAL, and LINE power) are remotely programmable. Function values, marker frequency/amplitude, and A/B traces may be output; CRT labels and graphics may be input.

LCL Returns analyzer to local control, if not locked out by controller.

Service request

SHIFT r calls an GP-IB request for service.

GP-IB interface functions

SH1, AH1, T6, L4, SRI, RL1, PPO, DC1, CI, C2, C3, C28, E2

Options

All specifications for options are identical to standard 85668 except as noted.

400 Hz Power line frequency operation (Option 400)

Power line related sidebands (center frequency from 100 Hz to 5.8 GHz)

Offset from Carrier	Sideband Level
< 2 kHz	-55 dBc
2 kHz to 5.5 kHz	-65 dBc

Power requirements

Line frequency	400 Hz ±10% line frequency (50 to 60 Hz operation for servicing only)
Line voltage	100 to 120 v (+5%, -10%)

Operating temperature range

400 Hz	0 ° to 55 °C
50 Hz to 60 Hz	0 ° to 40 °C

(service only, not for extended periods)

Part Numbers

- 8566B spectrum analyzer** – 100 Hz to 22 GHz
- Option R02** Turbo retrofit kit for any 8566B
 - Option 002** Turbo option for faster measurements
 - Option 010** Rack mount slide kit
 - Option 016** Installed EMI receiver functions
 - Option 031** German operating manual
 - Option 080** Information card in Japanese
 - Option 081** Information card in French
 - Option 1BN** MIL-STD 45662A calibration certification
 - Option 1BP** MIL-STD 45662A calibration certification with test data
 - Option 400** 400 Hz operation
 - Option 462** 100 Hz, 1 kHz, and 1 MHz
Impulse bandwidth filters for EMI measurements
 - Option 908** Rack flange kit without handles
 - Option 910** Extra operating and test and adjustment manuals
 - Option 913** Rack flange kit with handles
 - Option 915** Troubleshooting and repair manual set
 - Option W30** 3-year customer return repair
 - Option W32** 3-year customer return calibration

8566AB Retrofit kit to convert 8566A to 8566B

Recommended accessories

- 85644A** Tracking source 300 kHz to 6.5 GHz
- 85645A** Tracking source 300 kHz to 26.5 GHz
- 8449B** Preamplifier 1 to 26.5 GHz
- 11975A** Amplifier 2 to 8 GHz

Preselected mixers

- 11974A** 26.5 to 40 GHz preselected mixer
- 11974Q** 33 to 50 GHz preselected mixer
- 11974U** 40 to 60 GHz preselected mixer
- 11974V** 50 to 75 GHz preselected mixer
- 11974**
- Option 003** Delete power supply

Harmonic mixers

- 11970K** 18 to 26.5 GHz mixer
- 11970A** 26.5 to 40 GHz mixer
- 11970Q** 33 to 50 GHz mixer
- 11970T** 18 to 40 GHz mixers, hardwood case, cables, tools
- Option 001** Add 40 to 60 GHz mixer
- Option 002** Add 33 to 50 GHz mixers
- 11970U** 40 to 60 GHz mixer
- 11970V** 50 to 75 GHz mixer
- 11970W** 75 to 110 GHz mixer

Option 009 Mixer connection set adds three 1-meter low-loss SMA cables, wrench, Alien screw driver for any 11970 series mixer.

www.agilent.com

Agilent Technologies' Test and Measurement Support, Services, and Assistance

Agilent Technologies aims to maximize the value you receive, while minimizing your risk and problems. We strive to ensure that you get the test and measurement capabilities you paid for and obtain the support you need. Our extensive support resources and services can help you choose the right Agilent products for your applications and apply them successfully. Every instrument and system we sell has a global warranty. Two concepts underlie Agilent's overall support policy: "Our Promise" and "Your Advantage."

Our Promise

Our Promise means your Agilent test and measurement equipment will meet its advertised performance and functionality. When you are choosing new equipment, we will help you with product information, including realistic performance specifications and practical recommendations from experienced test engineers. When you receive your new Agilent equipment, we can help verify that it works properly and help with initial product operation.

Your Advantage

Your Advantage means that Agilent offers a wide range of additional expert test and measurement services, which you can purchase according to your unique technical and business needs. Solve problems efficiently and gain a competitive edge by contracting with us for calibration, extra-cost upgrades, out-of-warranty repairs, and onsite education and training, as well as design, system integration, project management, and other professional engineering services. Experienced Agilent engineers and technicians worldwide can help you maximize your productivity, optimize the return on investment of your Agilent instruments and systems, and obtain dependable measurement accuracy for the life of those products.

For more information on Agilent Technologies' products, applications or services, please contact your local Agilent office.

Phone or Fax

United States:

(tel) 800 829 4444
(fax) 800 829 4433

Canada:

(tel) 877 894 4414
(fax) 800 746 4866

China:

(tel) 800 810 0189
(fax) 800 820 2816

Europe:

(tel) 31 20 547 2111

Japan:

(tel) (81) 426 56 7832
(fax) (81) 426 56 7840

Korea:

(tel) (080) 769 0800
(fax) (080)769 0900

Latin America:

(tel) (305) 269 7500

Taiwan:

(tel) 0800 047 866
(fax) 0800 286 331

Other Asia Pacific Countries:

(tel) (65) 6375 8100
(fax) (65) 6755 0042

Email: tm_ap@agilent.com

Contacts revised: 05/27/05

**The complete list is available at:
www.agilent.com/find/contactus**

Product specifications and descriptions in this document subject to change without notice.

© Agilent Technologies, Inc. 2005, 2004
Printed in USA, July 20, 2005
5091-3385E



Agilent Technologies